

SPARE PART KITS PRICELIST

50Hz END GUN BOOSTER PUMP

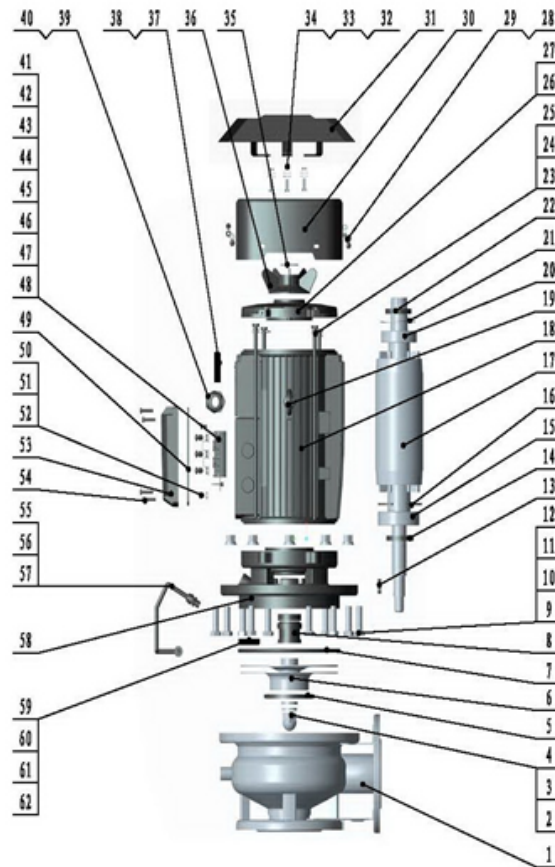

#	Description	QTY
1	Pump Body - Volute	1
2	Nut - Impeller	1
3	Spring Washer - Impeller	1
4	Washer - Impeller	1
5	Floating Seal Ring	1
6	Impeller	1
7	O'Ring - Volute/Backplate	1
8	Mechanical Seal	1
9	Spring Washer	10
10	Plain Washer	10
11	Nut	10
12	Bolt	10
13	Flat Key	1
14	Skeleton Oil Seal	1
15	Ball Bearing	1
16	Circlip Retaining Ring	1
17	Rotor	1
18	Stator	1
19	Eye Bolt	2
20	Ball Bearing	1
21	Wave Spring	1

#	Description	QTY
22	Frame Work Seal	1
23	Bolt	4
24	Plain Washer	4
25	Spring Washer	4
26	End Plate	1
27	Body Seal Ring	1
29	Plain Washer	4
28	Screw	4
30	Fan Cover	1
31	Motor Cowl	1
32	Bolt	3
33	Washer	6
34	Nut	3
35	Circlip Retaining Ring	1
36	Fan	1
37	Name Plate	1
38	Rivet	1
39	Cable Connector	1
40	Body Seal Ring	1
41	Number Tube W1	1
42	Number Tube V1	1

#	Description	QTY
43	Number Tube U1	1
44	Number Tube W2	1
45	Number Tube V2	1
46	Number Tube U2	1
47	Terminal Block	1
48	Terminal Screws	6
49	Terminal Cover Seal	1
50	Terminal Block Screw	1
51	Locking Washer Term Block	1
52	Spring Washer Term Block	1
53	Terminal Cover	1
54	Screw Terminal Cover	4
55	Tube Fitting	2
56	Tube Fitting	2
57	Seal Flush Tube	1
58	Backplate - Link Body	1
59	Guide Plate	2
60	Screw Guide Plate	2
61	Spring Washer Guide Plate	2
62	Plain Washer Guide Plate	2

50Hz END GUN BOOSTER PUMP SPARE PART KITS

Seal Kit

Code	Description	QTY
HC-EGBP50SK	Seal Kit	1
Includes:		
5	Floating Seal Ring	1
7	O'Ring - Volute/Backplate	1
8	Mechanical Seal	1

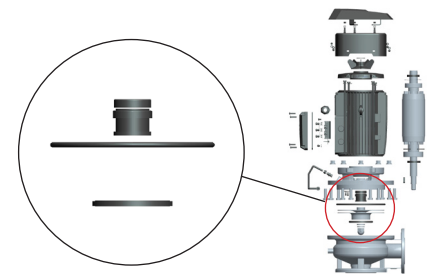

Impeller Kit

Code	Description	QTY
HC-EGBP5022IK	Impeller Kit 50Hz for 2.2kW	1
HC-EGBP5037IK	Impeller Kit 50Hz for 3.7kW	1
HC-EGBP6022IK	Impeller Kit 60Hz (125mm)	1
HC-EGBP6037IK	Impeller Kit 60Hz (140mm)	1
Includes:		
2	Nut - Impeller	1
3	Spring Washer - Impeller	1
4	Washer - Impeller	1
5	Floating Seal Ring	1
6	Impeller	1

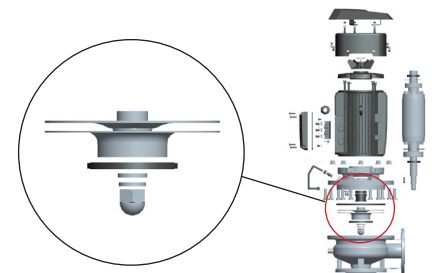

Pump Body Volute Kit

Code	Description	QTY
HC-EGBP50PBK	Pump Body Volute Kit	1
Includes:		
1	Pump Body - Volute	1
9	Spring Washer	10
10	Plain Washer	10
11	Nut	10
12	Bolt	10

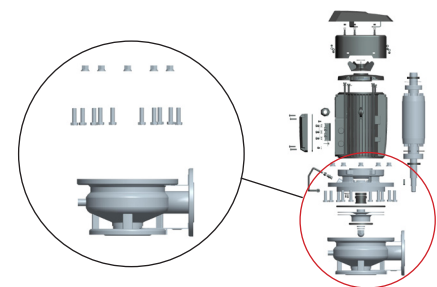

50Hz END GUN BOOSTER PUMP SPARE PART KITS

Motor Assembly

Code	Description	QTY
HC-EGBP5022MK	Motor Assembly for 2.2kW	1
HC-EGBP5037MK	Motor Assembly for 3.7kW	1
Includes:		
13	Flat Key	1
14	Skeleton Oil Seal	1
15	Ball Bearing	1
16	Circlip Retaining Ring	1
17	Rotor	1
18	Stator	1
19	Eye Bolt	2
20	Ball Bearing	1
21	Wave Spring	1
22	Frame Work Seal	1
23	Bolt	4
24	Plain Washer	4
25	Spring Washer	4
26	End Plate	1
27	Body Seal Ring	1
35	Circlip Retaining Ring	1
36	Fan	1
39	Cable Connector	1
40	Body Seal Ring	1
41	Number Tube W1	1
42	Number Tube V1	1
43	Number Tube UI	1
44	Number Tube W2	1
45	Number Tube V2	1
46	Number Tube U2	1
47	Terminal Block	1
48	Terminal Screws	6
50	Terminal Block Screw	1
51	Locking Washer Term Block	1
52	Spring Washer Term Block	1
58	Backplate - Link Body	1
59	Guide Plate	1
60	Screw Guide Plate	2
61	Spring Washer Guide Plate	2
62	Plain Washer Guide Plate	2

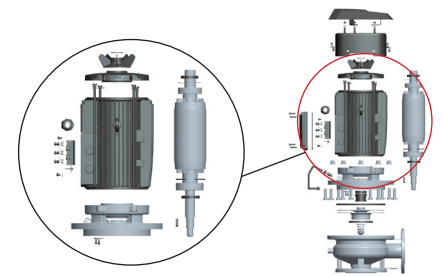

50Hz END GUN BOOSTER PUMP SPARE PART KITS

Backplate Kit

Code	Description	QTY
HC-EGBP50BPK	Backplate Kit	1
Includes:		
14	Skeleton Oil Seal	1
35	Circlip Retaining Ring	1
36	Fan	1
58	Backplate - Link Body	1
59	Guide Plate	2
60	Screw Guide Plate	2
61	Spring Washer Guide Plate	2
62	Plain Washer Guide Plate	2

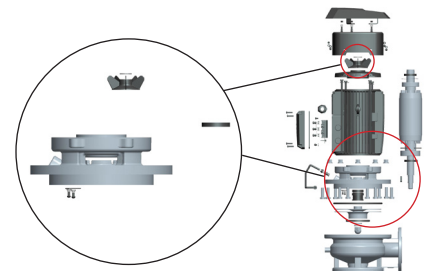

Motor Terminal Cover Kit

Code	Description	QTY
HC-EGBP50TCK	Motor Terminal Cover Kit	1
Includes:		
49	Terminal Cover Seal	1
53	Terminal Cover	1
54	Screw Terminal Cover	4

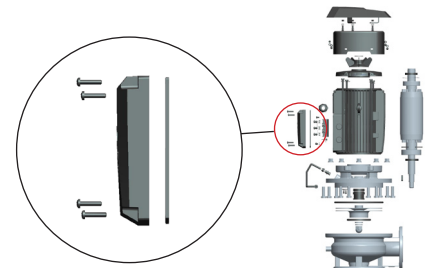

Motor Cowl & Cover Kit

Code	Description	QTY
HC-EGBP50FCK	Motor Cowl & Cover Kit	1
Includes:		
28	Screw	4
29	Plain Washer	4
30	Fan Cover	1
31	Motor Cowl	1
32	Bolt	3
33	Washer	6
34	Nut	3
35	Circlip Retaining Ring	1
36	Fan	1

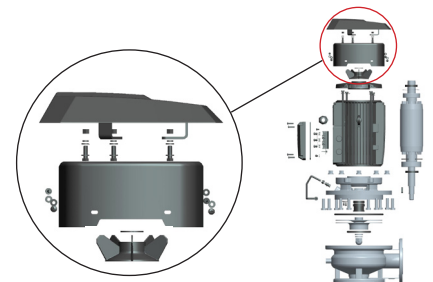

Seal Flush Tube Kit

Code	Description	QTY
HC-EGBP50FTK	Seal Flush Tube Kit	1
Includes:		
55	Tube Fitting	2
56	Tube Fitting	2
57	Seal Flush Tube	1

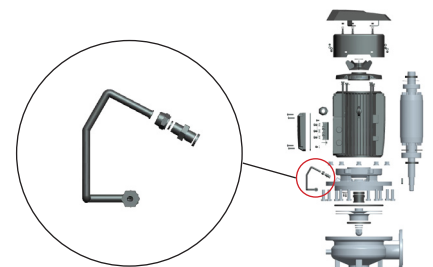

50Hz END GUN BOOSTER PUMP SPARE PART KITS

Motor Bearings & Fan Kit

Code	Description	QTY
HC-EGBP50BFK	Motor Bearing & Fan Kit	1
Includes:		
14	Skeleton Oil Seal	1
15	Ball Bearing	1
16	Circlip Retaining Ring	1
20	Ball Bearing	1
21	Wave Spring	1
22	Frame Work Seal	1
35	Circlip Retaining Ring	1
36	Fan	1

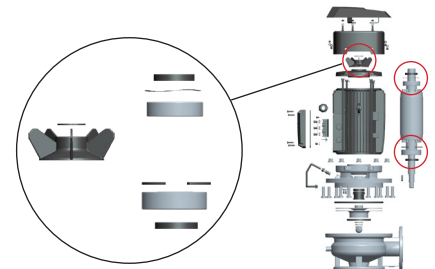

Motor Stator Kit

Code	Description	QTY
HC-EGBP5022MS	Motor Stator - 2.2kW Bare	1
HC-EGBP5037MS	Motor Stator - 3.7kW Bare	1
Includes:		
18	Stator	1
36	Fan	1
41	Number Tube W1	1
42	Number Tube V1	1
43	Number Tube UI	1
44	Number Tube W2	1
45	Number Tube V2	1
46	Number Tube U2	1

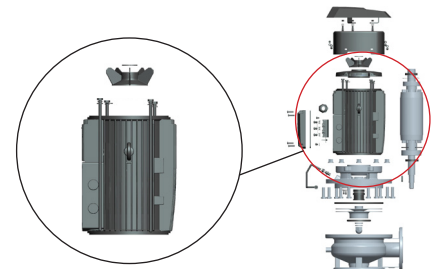

Motor Fan

Code	Description	QTY	QTY
HC-EGBP50FAN	Fan	1	1
Includes:			
35	Circlip Retaining Ring	1	

